

# Instrukcja montażu

odpływy liniowe

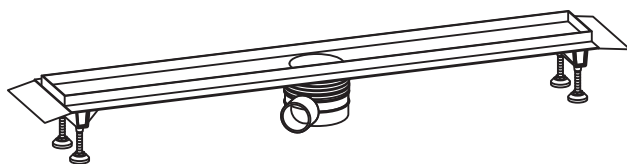

Nr kat.:	150 300	A = 500 mm	150 305	A = 1000 mm
	150 301	A = 600 mm	150 306	A = 1100 mm
	150 302	A = 700 mm	150 307	A = 1200 mm
	150 303	A = 800 mm		
	150 304	A = 900 mm		

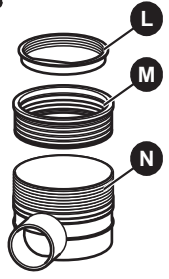
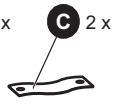
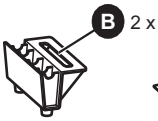
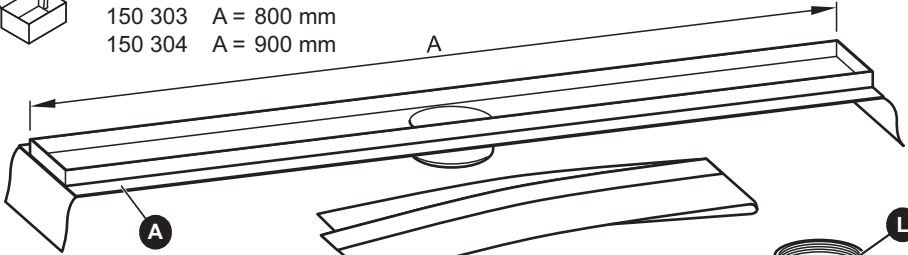



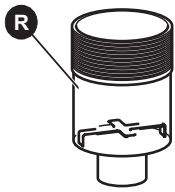

Nr kat.: 150 351

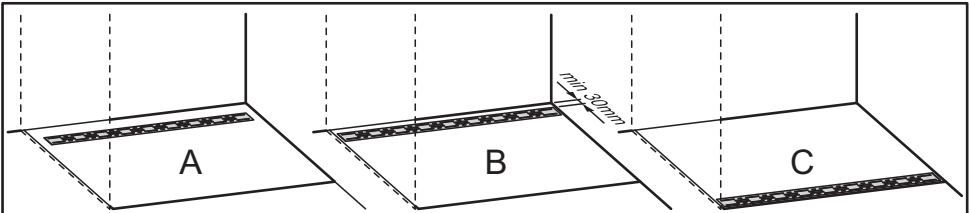

	Nr kat.:	150 308	A = 500 mm	150 313	A = 1000 mm	Design A
		150 309	A = 600 mm	150 314	A = 1100 mm	
		150 310	A = 700 mm	150 315	A = 1200 mm	
		150 311	A = 800 mm			
		150 312	A = 900 mm			

	Nr kat.:	150 316	A = 500 mm	150 321	A = 1000 mm	Design Plan
		150 317	A = 600 mm	150 322	A = 1100 mm	
		150 318	A = 700 mm	150 323	A = 1200 mm	
		150 319	A = 800 mm			
		150 320	A = 900 mm			

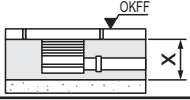
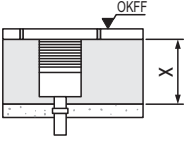

					
	A/B	C			
h1 = 50 mm	ca. 0,81 l/s	ca. 0,64 l/s	x = 110 - 125mm		
h2 = 30 mm	ca. 0,56 l/s	ca. 0,47 l/s	x = 80mm		
				x ≥ 110mm	

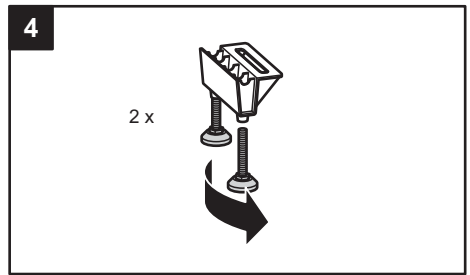
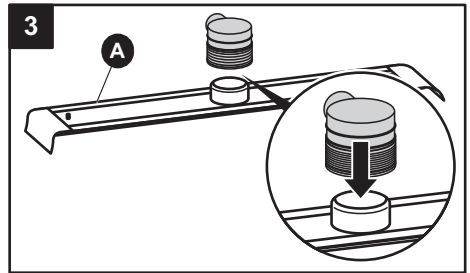
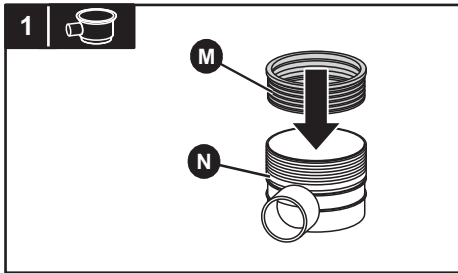
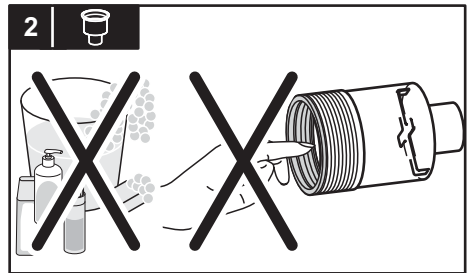
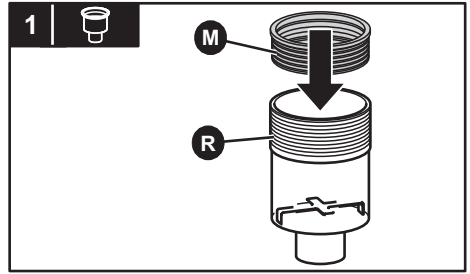
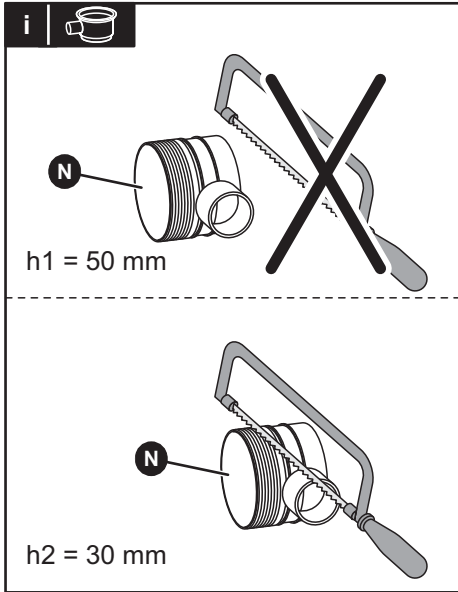

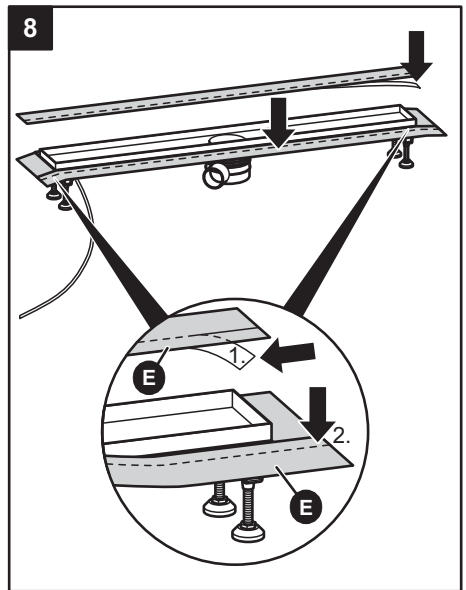
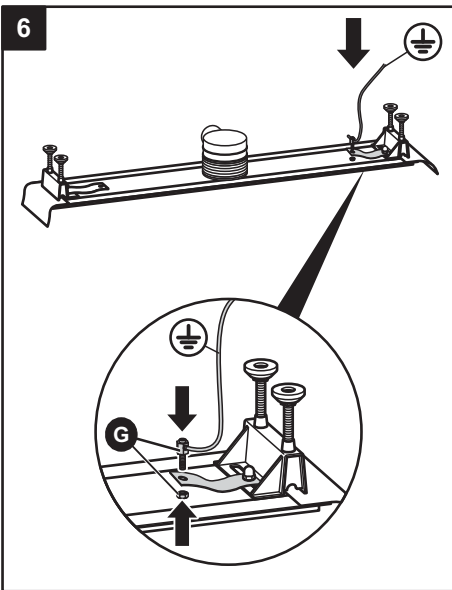
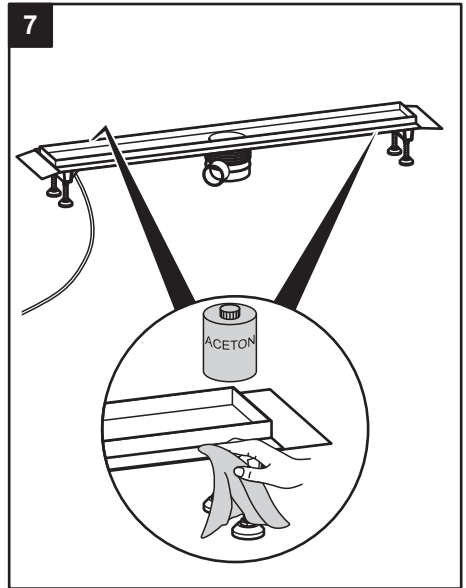
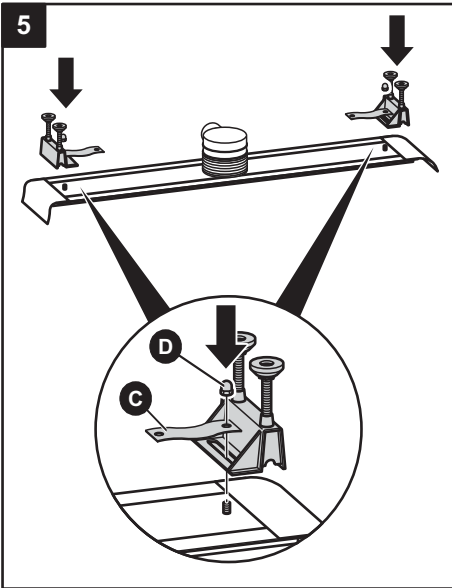

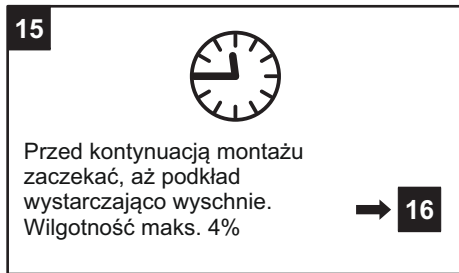
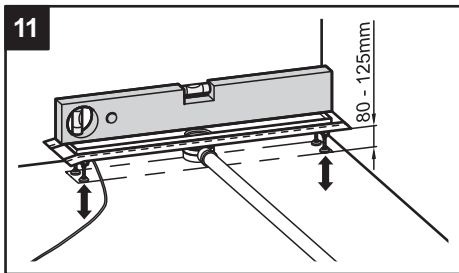
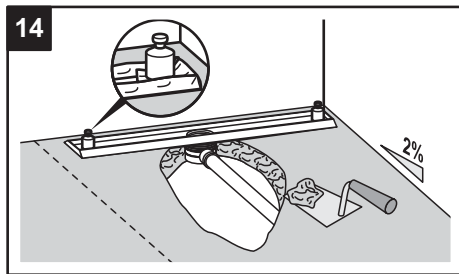
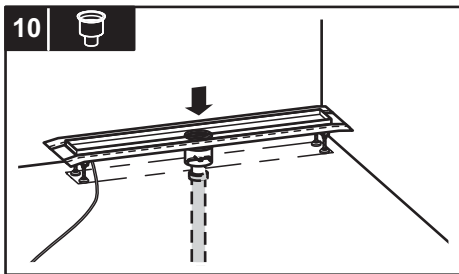
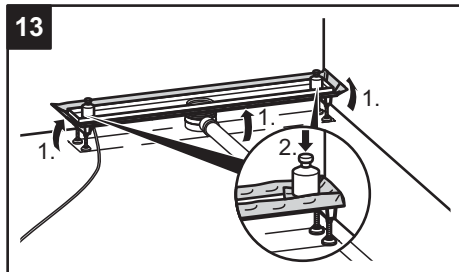
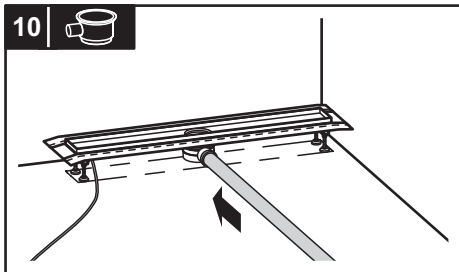
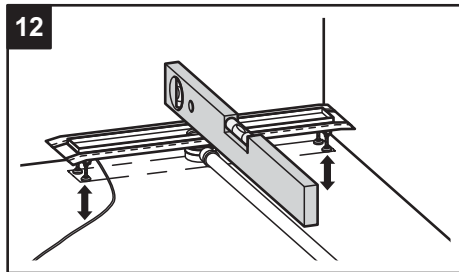
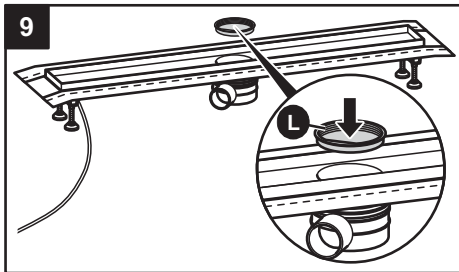

16

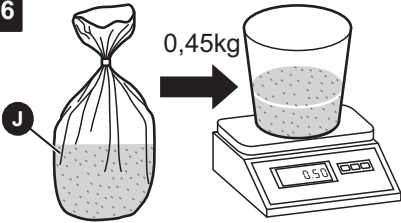

20

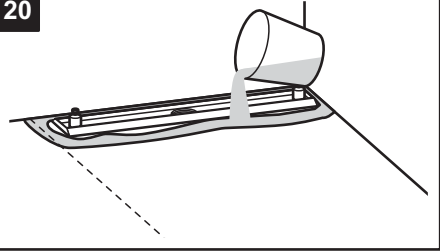

17

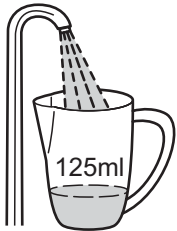

21

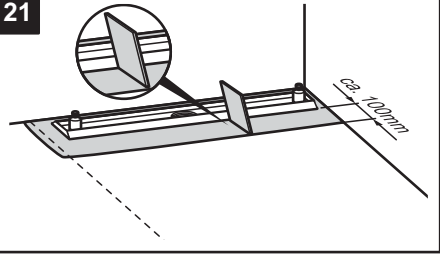

18



22

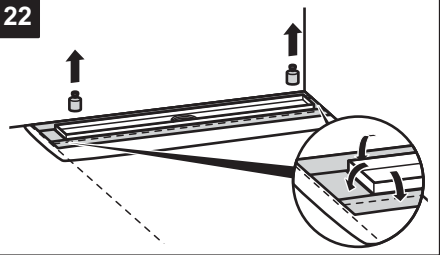

19



23

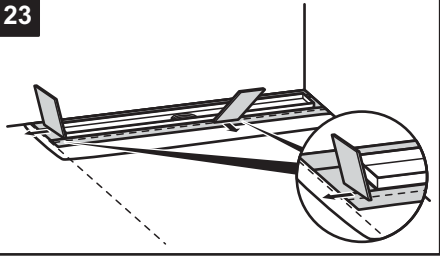



**24**

12h

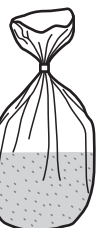
→ **25****28****25****J**

0,45kg

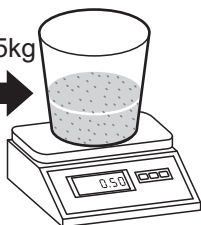
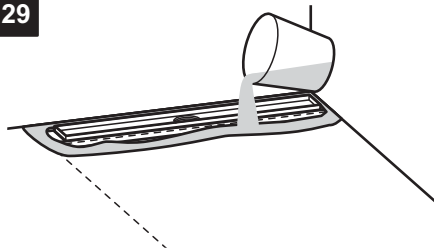
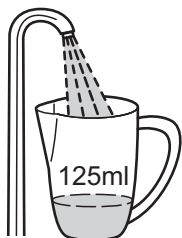
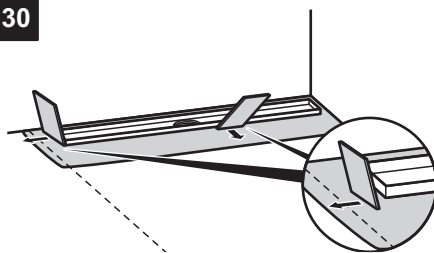
**29****26****30****27****31**

12h

→ **32**

32

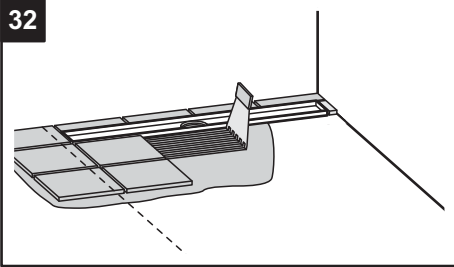

35

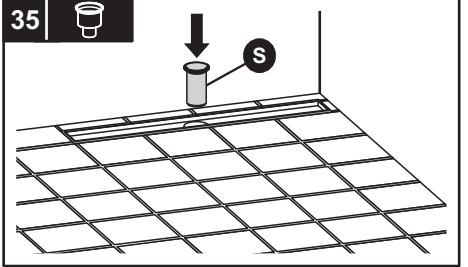

33

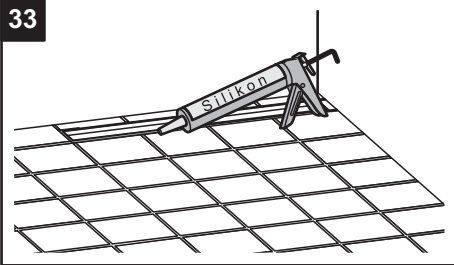

36

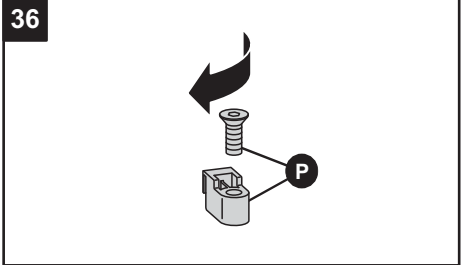

34

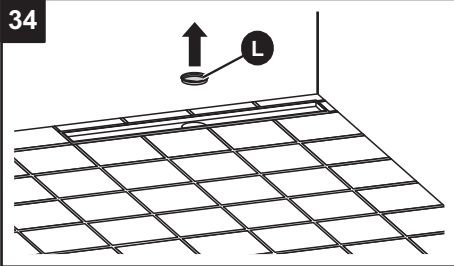

37

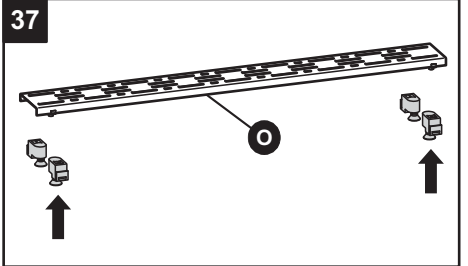

35

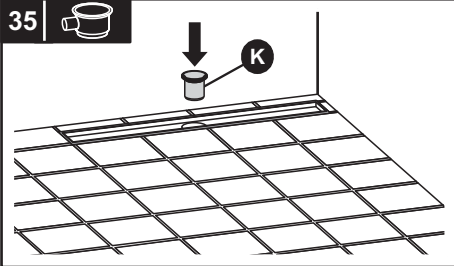

38

